

FS SERIES

ACCESS

FLOOR

SYSTEM



CAMINO

MODULAR SYSTEMS INC.

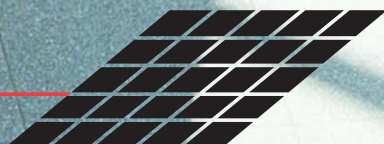

Slab Like Acoustics

OFFICE ENVIRONMENT

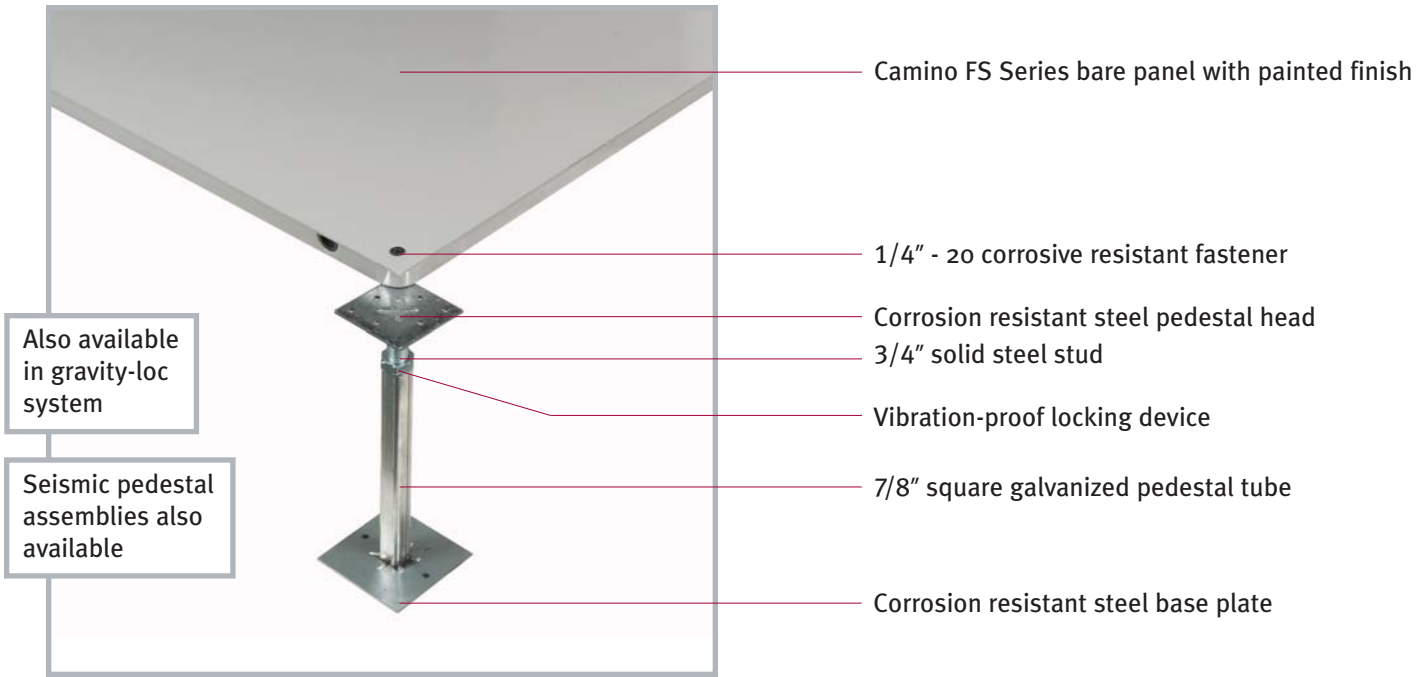

FS SERIES GENERAL OFFICE PANEL

The combination of a cementitious core and welded steel outer sheets provide superior strength and acoustics.

The surface preparation is typically bare, installed on stringerless understructure with corner bolted panels.



PANEL TYPE	1250/G0 IMPERIAL	1250/G0 METRIC	1500/G0 IMPERIAL	1500/G0 METRIC	2000/G0 IMPERIAL	2000/G0 METRIC
Concentrated Load*	1250 lbs.	5.6 kN	1500 lbs.	6.6 kN	2000 lbs.	8.9 kN
Uniform Load**	400 lbs.	17.78 kN/m ²	450 lbs.	23.11 kN/m ²	500 lbs.	27.56 kN/m ²
Rolling Load ***	1000/800 lbs.	4.4/3.6 kN	1250/1000 lbs.	5.6/4.4 kN	1500/1200 lbs.	6.7/5.6 kN
Ultimate Load*	3800 lbs.	16.9 kN	5000 lbs.	22.2 kN	6000 lbs.	26.7 kN
Size	24" x 24"	600 mm x 600 mm	24" x 24"	600 mm to 600 mm	24" x 24"	600 mm x 600 mm
Finished Floor Heights	2 1/2" to 24"	62 mm to 600 mm	2 1/2" to 24"	62 mm to 600 mm	2 1/2" to 24"	62 mm to 6000 mm
Understructure	Cornerlock	Cornerlock	Cornerlock	Cornerlock	Cornerlock	Cornerlock
Floor Finishes	Free lay carpet tile Factory bonded carpet	Free lay carpet tile Factory bonded carpet	Free lay carpet tile Factory bonded carpet	Free lay carpet tile Factory bonded carpet	Free lay carpet tile Factory bonded carpet	Free lay carpet tile Factory bonded carpet

* Measured on 1 sq.in. or 25 mm at any point.

**Measured on 1 sq.ft. or 30 cm x 30 cm area.

*** 3" diameter (76mm) x 1 13/16" wide (46mm) wheel./6" x 2" wheel

CISCA Test Procedures

and Exceptional Load Performance

COMPUTER ENVIRONMENT

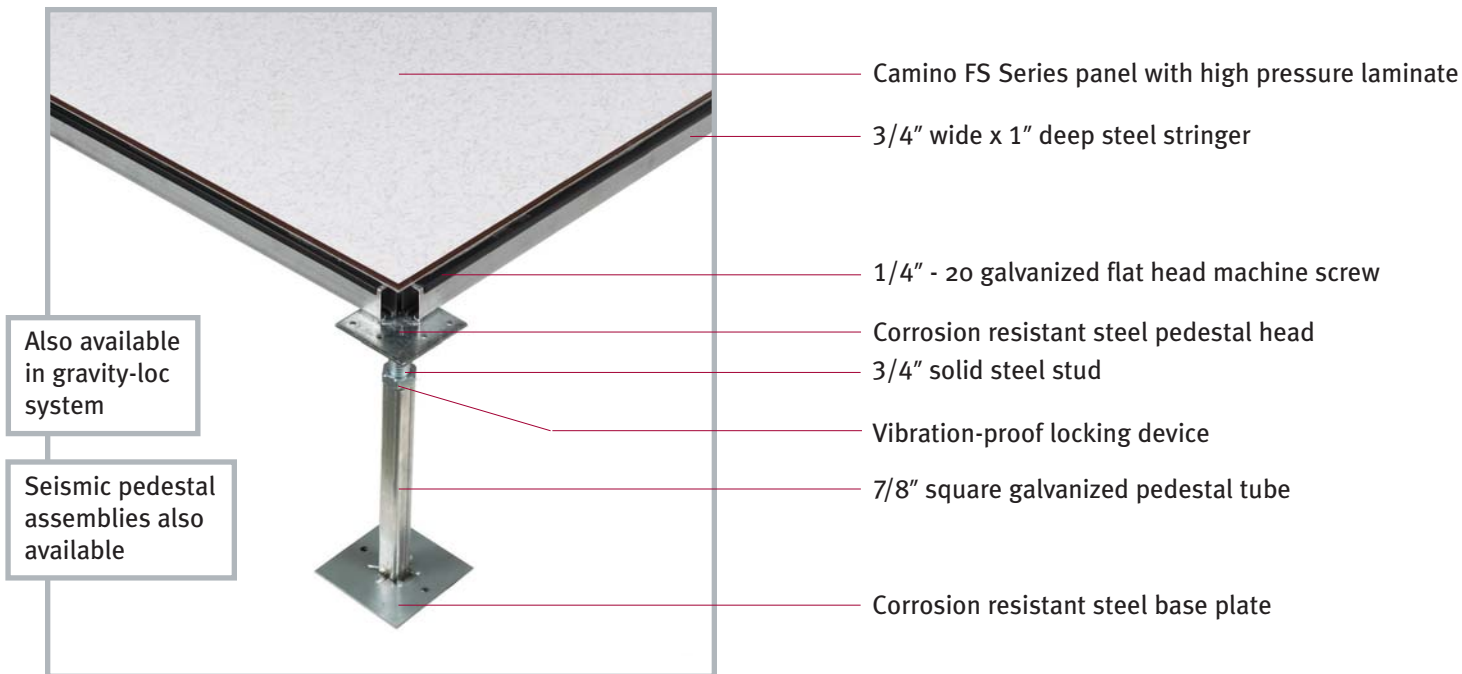

FS SERIES COMPUTER ROOM PANEL

The combination of a cementitious core strength and welded steel outer sheets have made this a superior and flexible panel to meet computer room requirements.

The FS Series / CR Panel combines a die cut steel top sheet and die cut formed bottom pan that are structurally welded and injected with foamed cement. The surface covering is typically a high pressure laminate, or reinforced vinyl.



PANEL TYPE	1250/CR IMPERIAL	1250/CR METRIC	1500/CR IMPERIAL	1500/CR METRIC	2000/CR IMPERIAL	2000/CR METRIC
Concentrated Load*	1250 lbs.	5.6 kN	1500 lbs.	6.6 kN	2000 lbs.	8.9 kN
Uniform Load**	400 lbs.	17.78 kN/m ²	450 lbs.	23.11 kN/m ²	500 lbs.	27.56 kN/m ²
Rolling Load ***	1000/800 lbs.	4.4/3.6 kN	1250/1000 lbs.	5.6/4.4 kN	1500/1200 lbs.	6.7/5.6 kN
Ultimate Load*	3800 lbs.	16.9 kN	5000 lbs.	22.2 kN	6000 lbs.	26.7 kN
Size	24" x 24"	600 mm x 600 mm	24" x 24"	600 mm to 600 mm	24" x 24"	600 mm x 600 mm
Finished Floor Heights	3" to 60"	75 mm to 1500 mm	3" to 60"	75 mm to 1500 mm	3" to 60"	75 mm to 1500 mm
Understructure	Bolted stringer	Bolted stringer	Bolted stringer	Bolted stringer	Bolted stringer	Bolted stringer
Floor Finishes	High pressure laminate Conductive vinyl	High pressure laminate Conductive vinyl	High pressure laminate Conductive vinyl	High pressure laminate Conductive vinyl	High pressure laminate Conductive vinyl	High pressure laminate Conductive vinyl

* Measured on 1 sq.in. or 25 mm at any point.

**Measured on 1 sq.ft. or 30 cm x 30 cm area.

*** 3" diameter (76mm) x 1 13/16" wide (46mm) wheel./6" x 2" wheel

CISCA Test Procedures

Static Dissipative Finishes

Durable and Attractive Equipment Room Surfaces

SYSTEM HIGHLIGHTS

- Superior wear resistance, efficient static control, and an attractive appearance.
- Choices of two trim styles: Camino TL-TOP lock trim and Camino IT-LAM Impregnated Trim.
- Requires minimal maintenance, damp mop only and no waxing.



Camino TL-TOP Lock Trim
High Pressure Laminate



Camino IT-LAM
Impregnated Trim
High Pressure Laminate

Static Dissipative Laminate
Max Resistance of 10^{10} ohms

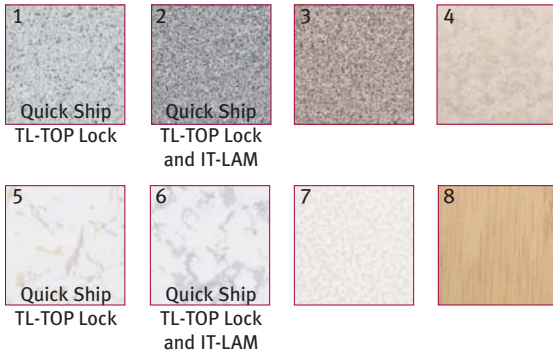

Available in 1/16" (1.6 mm)
or 1/8" (3.2 mm)

Conductive Vinyl
Max Resistance of 10^6 ohms

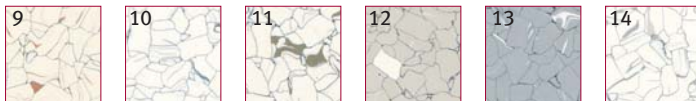

QUICK SHIP INVENTORY

Quick Ship Inventory in stock colour ranges can accommodate fast track projects.



Air Distribution Products

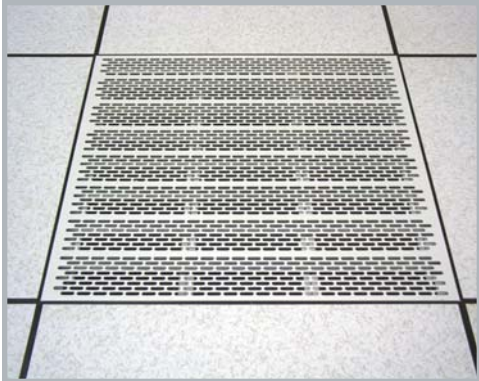

Perf 50 Air Flow Panel

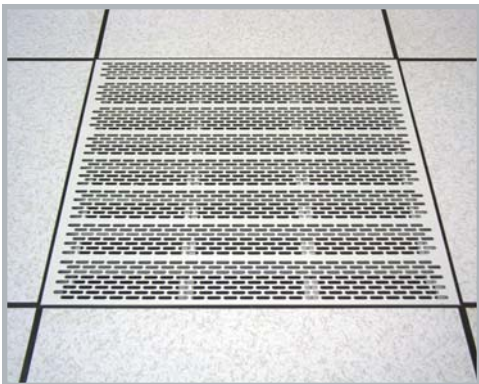
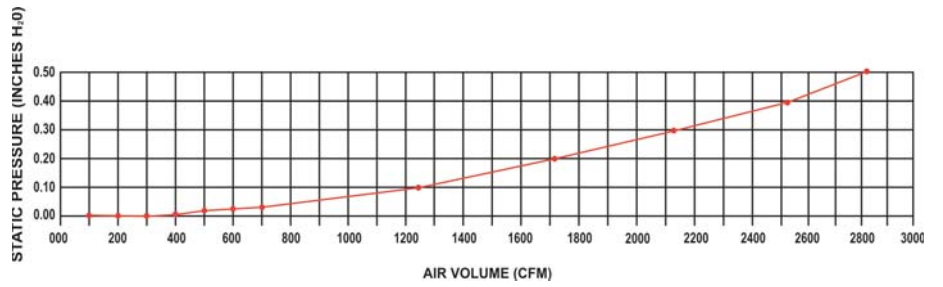

Perf 35 Air Flow Panel

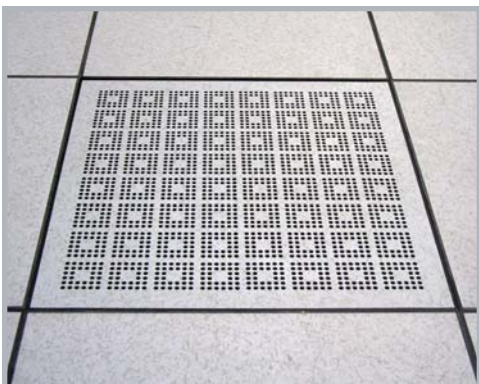
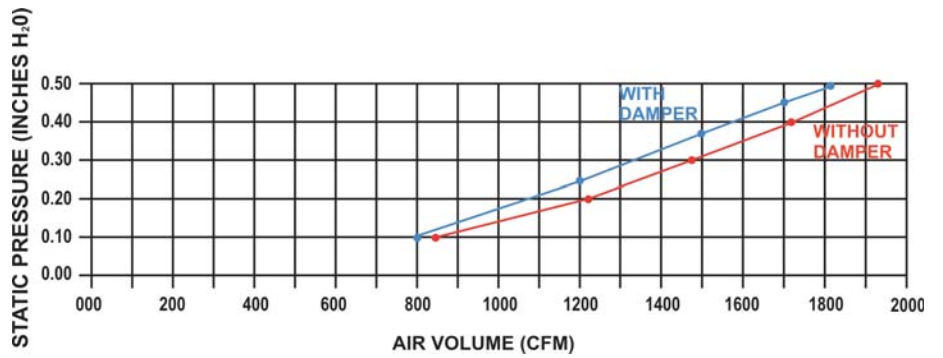

Perf 1000 Air Flow Panel

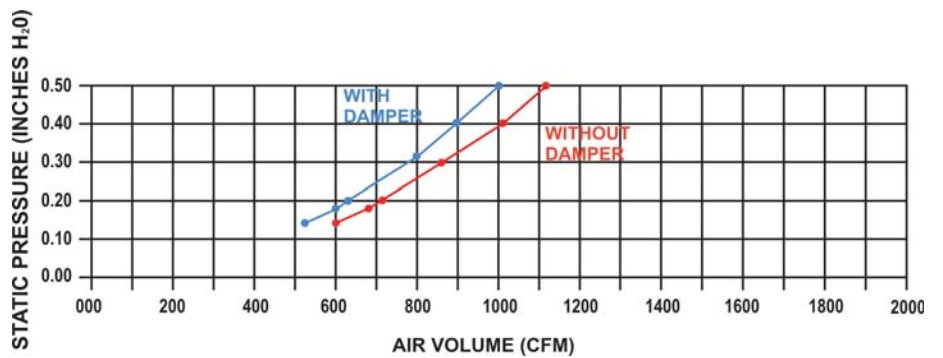

Accessories



Lifters



Ramp Kits



Step / Handrail Kits



Re-inforced pedestals for heavy loads such as UPS and Battery Packs

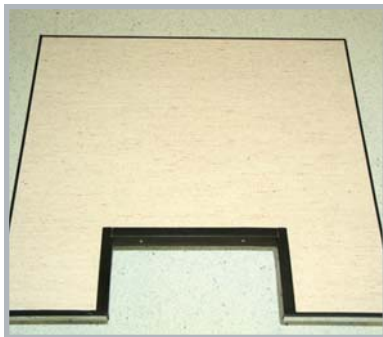

Standard Vinyl Trim Cutout

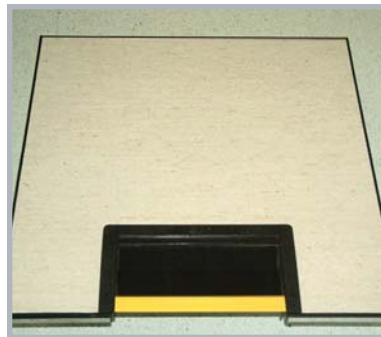

Cutout Trim with Brush Insert

CAMINO FLEX PLUG AND PLAY wiring systems are compatible with all types of furniture systems.



SDR-120-2D



CHR-120-3D



SDR-120-4D

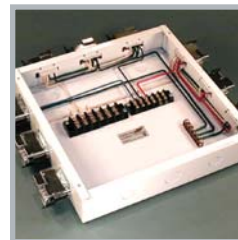

Power Distribution Box



Cable Set

CAMINO AIR FLOW PRODUCTS



75 CFM
Round Floor Diffuser,
available in manual
or automatic



150 CFM
Rectangle or square floor diffuser,
available in manual
or automatic



Linear Bar Grilles

Quality Assurance



Stringent quality control measures, independent lab testing and factory supervised installations ensure only the highest performance standards.

All testing has been completed in accordance with CISCA test procedures by certified independent North American Laboratories.

TEST REPORT



PROJECT NUMBER: 3115553
REPORT NUMBER: 1
 ORIGINAL ISSUE DATE: FEBRUARY 15, 2007

EVALUATION CENTRE
 Intertek Testing Services NA Ltd.
 3210 American Drive
 Mississauga, ON L4V 1B3

RENDERED TO:
 Camino Modular Systems Incorporated
 89 Castlegrove Drive
 Etobicoke, Ontario, Canada, M9W 5E4

PRODUCT EVALUATED:
 FS 1250 Bare Corner Lock Access Floor Panels

EVALUATION PROPERTY:
 Concentrated Load and Ultimate Load

Report of Testing of FS 1250 Bare Corner Lock Access Floor Panels for compliance with the applicable requirements of the following criteria: CISCA (Ceiling & Interior Systems Construction Association) Recommended Test Procedures For Access Floors 2004

TEST REPORT



PROJECT NUMBER: 3115513
REPORT NUMBER: 1
 ORIGINAL ISSUE DATE: FEBRUARY 15, 2007

EVALUATION CENTRE
 Intertek Testing Services NA Ltd.
 3210 American Drive
 Mississauga, ON L4V 1B3

RENDERED TO:
 Camino Modular Systems Incorporated
 89 Castlegrove Drive
 Etobicoke, Ontario, Canada, M9W 5E4

PRODUCT EVALUATED:
 FS 1250 Access Floor Panels with Stringers

EVALUATION PROPERTY:
 Concentrated Load and Ultimate Load

Report of Testing of FS 1250 Bare Corner Lock Access Floor Panels with Stringers for compliance with the applicable requirements of the following criteria: CISCA (Ceiling & Interior Systems Construction Association) Recommended Test Procedures For Access Floors 2004

TEST REPORT



PROJECT NUMBER: 3115513
REPORT NUMBER: 2
 ORIGINAL ISSUE DATE: FEBRUARY 15, 2007

EVALUATION CENTRE
 Intertek Testing Services NA Ltd.
 3210 American Drive
 Mississauga, ON L4V 1B3

RENDERED TO:
 Camino Modular Systems Incorporated
 89 Castlegrove Drive
 Etobicoke, Ontario, Canada, M9W 5E4

PRODUCT EVALUATED:
 FS 1250 Bare Corner Lock Access Floor Panels

EVALUATION PROPERTY:
 Rolling Load

Report of Testing of FS 1250 Bare Corner Lock Access Floor Panels for compliance with the applicable requirements of the following criteria: CISCA (Ceiling & Interior Systems Construction Association) Recommended Test Procedures For Access Floors 2004



Concentrated Load



Ultimate Load



Rolling Load

Camino Modular Systems Inc. established in 1970 is an international supplier of access floor systems.

Head Office and Factory

89 Carlingview Drive
Toronto, Ontario, Canada
M9W 5E4
Tel: 416-675-2400 / 1-800-370-0226
Fax: 416-675-2424 / 1-866-370-0226

Mid West Regional Sales Office

Chicago, IL
Tel: 847-427-1800
Fax: 847-427-8173

Southern Regional Sales Office

Dallas, TX
Tel: 972-788-2770
Fax: 972-866-9160

West Coast Regional Sales Office

Vancouver, BC
Tel: 604-267-2400
Fax: 604-267-2402

North East Regional Sales Office

Montreal, QC
Tel: 450-621-2450
Fax: 450-621-2402

www.camino-access-floors.com

Camino access floors have been installed for many of the worlds leading companies, including:

A.C. Nielson
Air Canada
Allstate Insurance
Amdahl
AT&T
Bank of Moscow
Bank of Montreal
Bank of Nova Scotia
Banko Sandander
Bell Telephone
Cantel
Charles Schwabb
Chase Manhattan Bank
Chrysler
CIBC
Citicorp Bank
Clearnet
Coca Cola Ltd.
Credit Suisse
Dai Ichi Bank
Deacon Barclays Bank
Dean Witter
Department of Defense
Discovery Museum
Dow Chemical

Exxon
Ford Motor Company
FUJI
General Motors
Hewlett Packard
Home Depot
HSBC
Hydro Quebec
IBM
Kellogg's
Kenya International Airport
Labatt's Brewery
Loblaws Head Office
MacMillan Bloedel
Mayo Clinic
McDonnell Douglas
MCI
Microsoft
Ministry of Finance
Ministry of Transportation
Molson's Brewery
Morgan Guaranty Trust
Motorola
Ontario Hydro
Open Text

Oracle Corporation
Pacific Bell
Pitney Bowes
Power Stream
Public Works Canada
RCMP
Regional Municipality of Niagara
Rockwell International
Rogers Communications
RBC Royal Bank
Shell Oil
Smith Carter Architects
Société Immobiliere du Quebec
Société Générale
Sprint
Teleglobe
TD Bank
United Airlines
U.S. Air Force
U.S. Navy
Union Bank of Switzerland
Volkswagen
Wrigley Canada

CAMINO

MODULAR SYSTEMS INC.

